

SOLIDS HANDLING PUMPS

Dimensional Data: **12ANC5000**

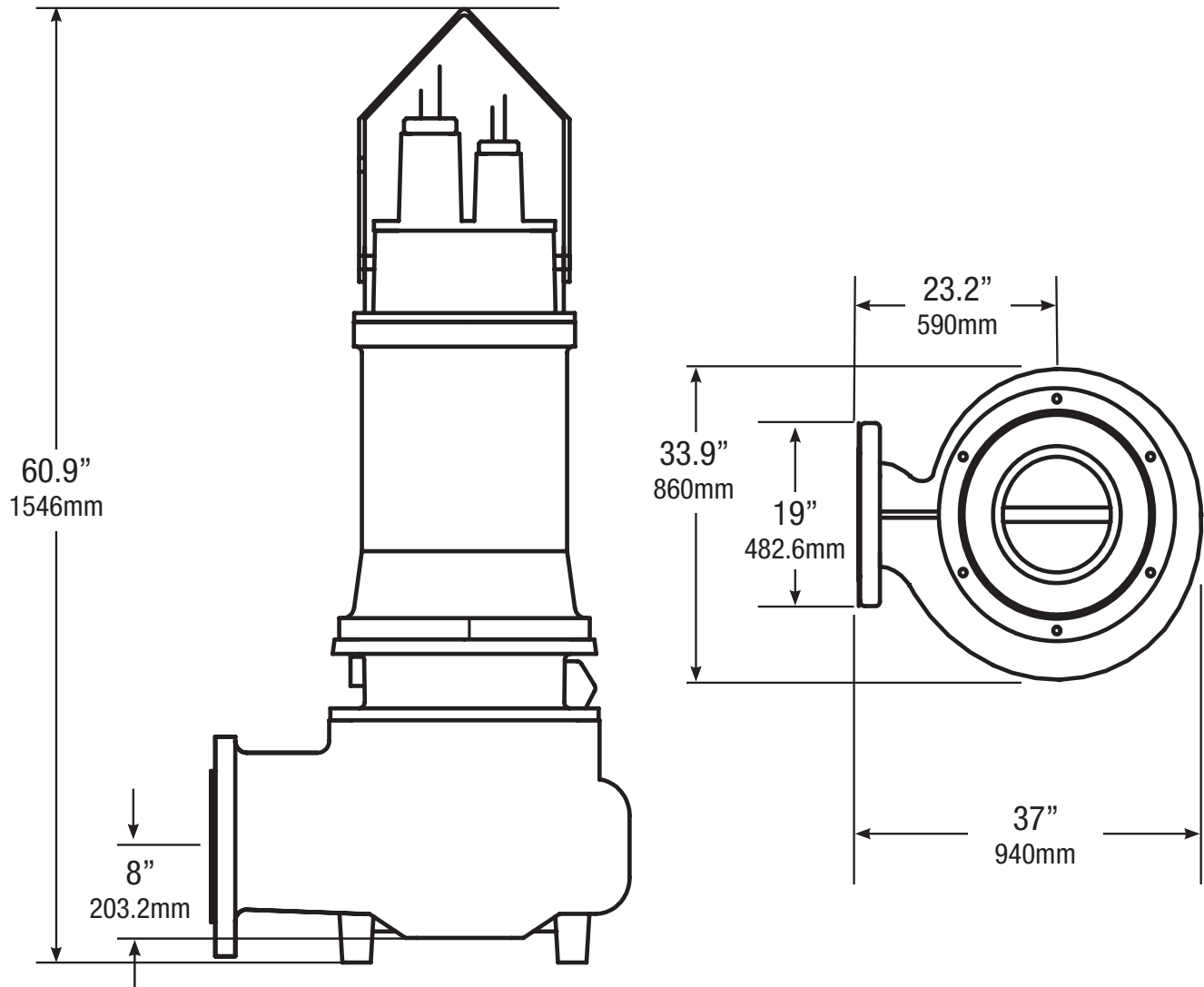

P U M P

Honest, Professional, Dependable

1191 Commerce Parkway, Ashland, Ohio 44805

Telephone: 855 281-6830 • Fax: 877 326-1994 • ashlandpump.com